

Technical Description and Operating Instructions

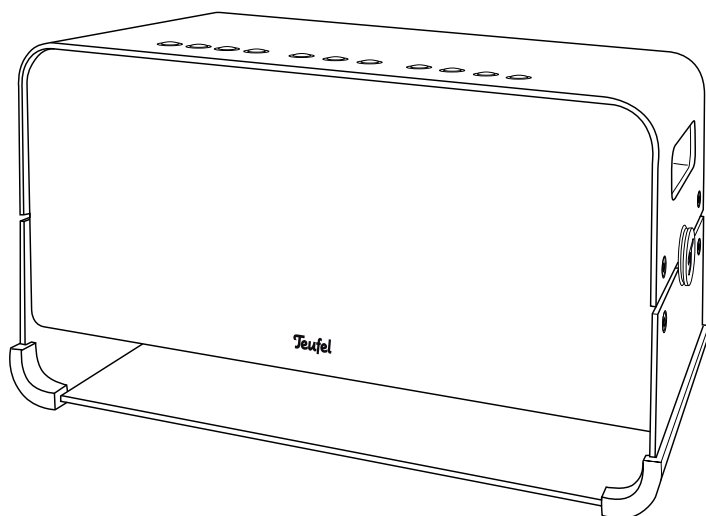

BOOMSTER XL

Mobile active Bluetooth® speaker with integrated FM radio

Teufel

Contents

General Notes and Information	3	Tone	15
Notice	3	Setting the bass tones (subwoofer).....	15
Trademarks	3	Setting the treble tones	16
Original packaging	3	Preset sound configuration.....	16
Complaints	3	Saving personal sound configura- tions	17
Contact	4	Radio	18
Proper use.....	4	Selecting the radio	18
Explanation of symbols.....	4	Setting stations	18
For Your Safety	5	Saving and accessing stations ..	18
Caution items.....	5	AUX	19
Safety notes	5	Connection	19
Overview	8	Playback.....	19
Unpacking	8	Bluetooth®.....	20
Product contents.....	8	Bluetooth® options	20
Optional accessories.....	8	Pairing.....	20
Checking the product contents.....	8	Manual pairing	21
Operational Controls and Connections	9	Pairing via NFC	22
Preparation	10	Playback.....	22
Power supply	10	Terminating the connection.....	23
AC power	10	USB.....	23
Battery pack.....	10	Remote Control.....	24
External 12 volt source	12	Pairing the “Teufel Puck”.....	24
Attaching the carrying strap	12	Functions.....	24
Operation.....	13	Changing the batteries	25
Turning on and off.....	14	Cleaning & Maintenance	26
Turning on.....	14	Troubleshooting	27
Turning off.....	14	Protecting the Environment.....	28
Auto-off.....	14	Technical Data	29
Sequential light.....	14	Declaration of conformity	30
Selecting a source	15		
Volume.....	15		
Setting the master volume	15		

General Notes and Information

Notice

The information in this document may change without prior notice and in no way constitutes any liability on the part of Lautsprecher Teufel GmbH.

No part of this user manual may be reproduced in any form or be broadcast in any way electronically, mechanically, by photocopy or recording without the written permission of Lautsprecher Teufel GmbH.

© Lautsprecher Teufel GmbH

Version 1.0

November 2015

Trademarks

© All trademarks are the property of their respective owners.

Bluetooth®

Bluetooth® and the Bluetooth symbol are trademarks of Bluetooth SIG, Inc.



aptX® and the aptX symbol are trademarks of CSR plc or associated companies and may be protected in multiple countries.

 The “N-Mark” symbol is a trademark or registered trademark of NFC Forum, Inc. in the USA and other countries.

Original packaging

If you wish to exercise your eight-week right of return, we ask that you be absolutely sure to hold on to the packaging. We can only accept the return of the speakers WITH THE ORIGINAL PACKAGING.

Empty boxes are not available!

Complaints

In case of a complaint, we will need the following information to process your enquiry:

1. Invoice number

Can be found on the sales slip (enclosed with the product) or on the order confirmation received as a PDF document, e.g. 4322543

2. Serial number or batch number

Located on the bottom of the device, e.g. serial no.: KB20240129A-123.

Thank you for your support!

Contact

Please contact our customer service with any questions, suggestions or concerns:

Lautsprecher Teufel GmbH

BIKINI Berlin

Budapester Str. 44

10787 Berlin (Germany)

Phone 00800 - 200 300 40 (toll-free)

Fax +49 (0)30 / 300 930 930

E-mail: service@teufelaudio.com

teufelaudio.com



Before operating the speakers, please read the safety notes and user manual carefully.

Only in this way can you ensure that all functions are used in a safe and reliable manner. Store the user manual in a safe place and also be sure to pass it on to any subsequent owner.

Explanation of symbols



Protection class II

Dual insulation

Proper use

The speaker is designed for the playback of music and speech from the integrated FM radio or an external player.

Only use the speaker as described in this user manual. Any other use will be deemed as not in accordance with the instructions and may lead to damage of property or even persons.

The manufacturer accepts no liability for damage caused by improper use.

The speaker is only intended for private use.

For Your Safety

Caution items

You can find the following caution items in this user manual:

WARNING

This signal term indicates a moderate risk, which, if not avoided, may result in death or severe injury.

CAUTION

This signal term indicates a low risk, which, if not avoided, may result in minor or moderate injury.

NOTICE

This signal term warns you of potential damage to property.

Safety notes

Improper electrical installation or excessive mains voltage may result in an electrical shock.

- The device is suitable for a mains voltage of 230 V, 50 Hz. When connecting the device, make sure that the correct voltage is present. You can find more information about this on the rating plate.
- Check the device regularly for damage. Immediately disconnect the mains plug and do not operate the device if

its housing or mains cord is defective or exhibits other visible damages.

- If the mains cord is damaged, replace it with an equivalent one.
- The rechargeable battery switch (14) on the back side of the device does not disconnect the device from the mains. The complete separation from the mains can only be carried out by pulling the plug. Thus, make sure that the mains plug is always easily accessible.
- If the device emits smoke, smells burnt or produces unusual sounds, immediately disconnect it from the mains and do not operate it further.
- Never open the device housing. Repairs may only be carried out by an authorised specialist workshop. In the process, only parts that correspond to the original device data may be used.
- Only use the accessory products specified by the manufacturer.
- Only use the device indoors when it is plugged into the mains.
- Do not operate the device in wet rooms and protect it from dripping and splashing water. Make sure that no vases or other liquid-filled containers are located on or nearby the device in order to prevent liquid from penetrating the housing. If water or other debris ends up penetrating the housing, immediately pull the mains plug and take out any batteries/rechargeable batteries.

Then send the device to our service address.

- Never modify the device. Unauthorised interventions may affect the safety and functionality.
- Never touch the mains plug with wet hands.

An unsuitable setup location may result in injury and damage.

- If the speaker is not securely mounted, do not use it in vehicles, in unstable locations, on wobbly tripods or furniture, on undersized brackets etc. The speaker may tip or fall over and cause injury to persons or be damaged itself.
- Place the speaker in such a way that it cannot be knocked over inadvertently and make sure that the cables do not pose a trip hazard.
- Do not place the speaker near heat sources (e.g. heaters, ovens, other heat generating equipment such as amplifiers etc.).
- Do not use the device in environments where there is a risk of explosion.
- Only use the Bluetooth® function in locations where wireless radio transmission is allowed.

Children can become trapped in the package wrapping when playing and suffocate.

- Do not allow children to play with the device or the package wrapping. Danger of suffocation.
- Ensure that children do not remove small parts from the device or take them off of the device (e.g. control knobs or plug adapters). They could swallow the parts and choke.
- Never allow children to operate electrical devices unsupervised.

Leaking battery acid may lead to chemical burns.

- Do not allow battery acid to come into contact with skin, eyes or mucus membranes. In the event of contact with acid, immediately flush the applicable areas with plenty of clean water and consult a physician if necessary.

Batteries (particularly lithium batteries) can explode if used improperly.

- Never attempt to recharge batteries.
- Only use batteries of the same or equivalent type.
- You must not heat or short circuit batteries and rechargeable batteries or dispose of them in a fire.
- Do not expose batteries and rechargeable batteries to direct sunlight.

Extended listening at high volumes may lead to hearing loss.

To avoid damage to health, avoid extended listening at high volumes.

- When the volume is set high, always keep a certain distance from the device and never place your ear directly on the speaker.
- If a speaker is set to full volume, this may produce very high sound pressure. This may have psychological consequences and also cause physical injury. Children and pets are particularly at risk. Set your signal source device volume control to a low setting before turning on the power.

Misuse can lead to accidents.

- Do not use the carrying strap as a climbing aid.

Overview

Unpacking

⚠ WARNING

Children can become trapped in the package wrapping when playing and suffocate.

- Do not allow children to play with the device or the package wrapping. Danger of suffocation.

Carefully open the box and carefully lift the BOOMSTER XL with the EPE foam parts out without touching the diaphragms of the bass speaker on the bottom of the device.

Product contents

- ① 1x BOOMSTER XL including Li-ion rechargeable battery
1x mains cord (not shown)
- ② 1x carrying strap

Optional accessories

- ③ Remote control "Teufel Puck"

Checking the product contents

- Check that all items have been delivered and that nothing is damaged.
- If the delivery is incomplete or exhibits transport damages, please contact our service team (see page 3).

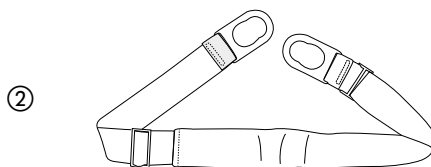
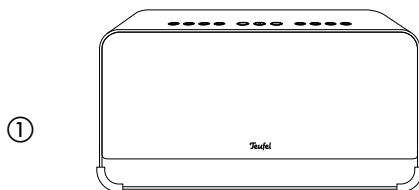



⚠ CAUTION

Do not operate the device if it is damaged in any way.

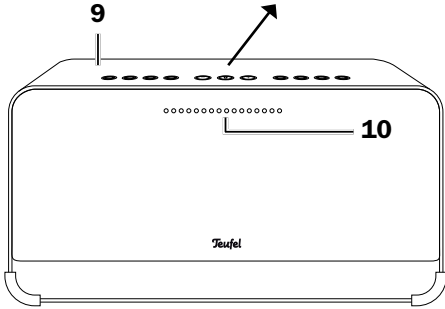
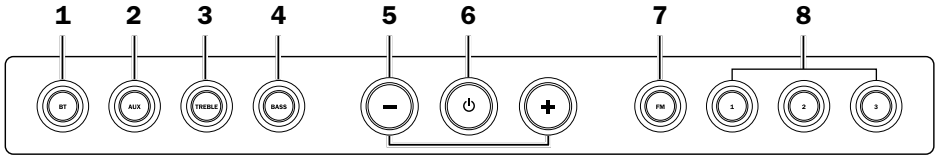
Operational Controls and Connections



- 1 BT:** Tap BT to select Bluetooth® as a source
Press and hold BT for pairing mode
- 2 AUX:** Select the **AUX (16)** input
- 3 TREBLE:** Set TREBLE
- 4 BASS:** Set BASS
- 5 -/+:** Reduce (-)/increase (+) the volume, treble, bass
- 6 Tap **:
Turn the device on/off
Press and hold :
Activate/deactivate the LED sequential light
- 7 FM:** Select FM radio/set stations
- 8 1, 2, 3:** Memory buttons for radio stations and sound configurations
- 9** NFC contact zone
- 10** Volume LEDs to display the volume, bass and treble
- 11** Rechargeable battery compartment
- 12** Rechargeable battery connector jack
- 13** Mains jack
- 14** Rechargeable battery switch
- 15** Input jack for external mains adapter, e.g. car adapter (not included in the product contents)
- 16** AUX input jack
- 17** USB jack (power supply for external players)
- 18** Dipole FM antenna

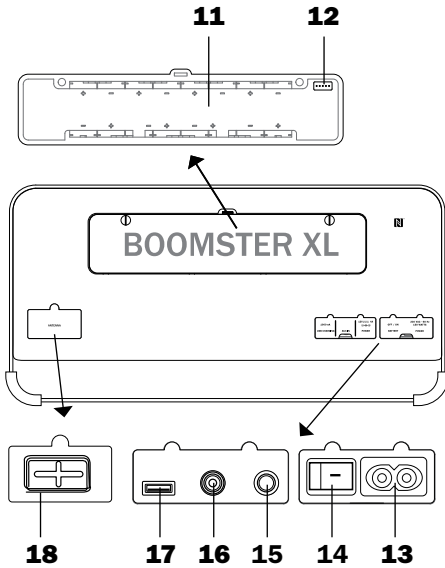

Preparation

Power supply

The BOOMSTER XL offers three power supply options:

- Mains current
- Rechargeable battery
- External 12 volt source

AC power

For stationary operation, insert the enclosed mains cord into the mains jack **(13)** and connect it to a mains socket.

Battery pack



Rechargeable Batteries (particularly lithium-ion batteries) can explode if used improperly.

- *You must not heat or short circuit batteries and rechargeable batteries or dispose of them in a fire.*
- *Do not expose batteries and rechargeable batteries to direct sunlight.*

Leaking battery acid may lead to chemical burns.

- *Do not allow battery acid to come into contact with skin, eyes or mucous membranes.*

In the event of contact with acid, immediately flush the applicable areas with plenty of clean water and consult a physician if necessary.

NOTICE

A deep discharge irreparably damages the rechargeable battery.

- Charge the rechargeable battery as soon as the LED display **(10)** blinks 3 times every 5 seconds.

To protect the rechargeable battery, the BOOMSTER XL has deep discharge protection, which switches the device off once the threshold has been reached.

i When the rechargeable battery charge diminishes or the batteries get low, the LED display **(10)** will blink 3 times every 5 seconds. In this case, replace the batteries or connect the mains cord.

The enclosed Li-ion battery pack will be charged as soon as the BOOMSTER XL is connected to the mains and the rechargeable battery switch **(14)** is switched on ("I" position).

Before first use, charge the rechargeable battery for approx. 3.5 hours.

During the charging process, the **⏻** button **(6)** will flash. It will stop flashing once the rechargeable battery has been fully charged.

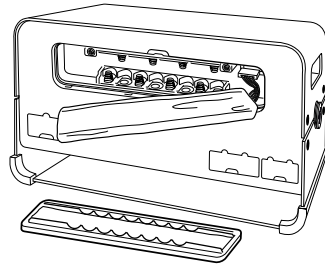
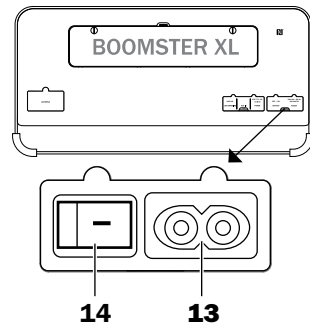

External 12 volt source

You can connect an external 12 volt source (e.g. a car battery) to jack **(15)**. The rechargeable battery will not be charged via this connection.

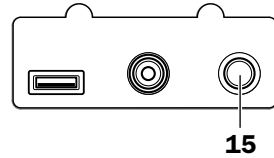

Attaching the carrying strap

Hook the strap **(3)** in the brackets **(a)**.

CAUTION

- Do not use the carrying strap as a climbing aid.

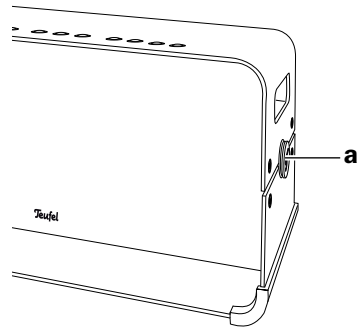
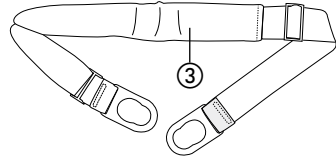

Operation

CAUTION



Extended listening at high volumes may lead to hearing loss.

- *To avoid damage to health, avoid extended listening at high volumes.*
- *When the volume is set high, always keep a certain distance from the device and never place your ear directly on the speaker.*
- *If a speaker is set to full volume, this may produce very high sound pressure. This may have psychological consequences and also cause physical injury. Children and pets are particularly at risk. Set your signal source device volume control to a low setting before turning on the power.*



NOTICE

If the device is subjected to warm temperatures after being cold (e.g. after transport), condensation may occur inside of it.

- *In this case, wait at least 2 hours before you connect and activate it.*

Turning on and off

Turning on

- Push the  button **(6)** for approx. one second to turn on the BOOMSTER XL. When the device is turned on, all of the LEDs will light up.
- If you would like to turn off all of the LEDs, press and hold the  button **(6)** until the  button-LED begins to blink. Turning them back on is done in the same manner.

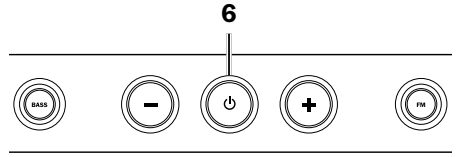

Turning off

- Push the  button **(6)** again to switch the BOOMSTER XL off. The BOOMSTER XL will be
 - off when using battery power,
 - in standby mode when plugged in.
- In case of prolonged non-use, turn the rechargeable battery switch **(14)** off. This will completely disconnect the rechargeable battery from the mains thus preventing a deep discharge.

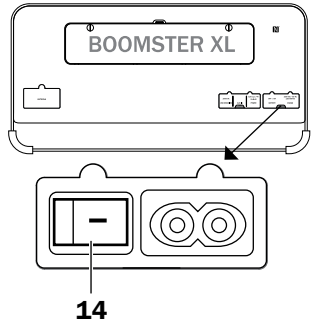

Auto-off

- The device will automatically deactivate if no input signal is received for 20 minutes.

Sequential light

- Every time the device is turned on and off, the volume LEDs will run for 5 seconds (“Knight Rider mode”).
- Pushing and holding the  button **(6)** (for approx. 3 seconds) will switch the LED running lights on and off.

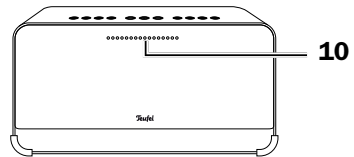

Selecting a source

- With the buttons **(1)**, **(2)** and **(7)**, select the external player (source) or radio operation.

The active source or the selected FM station as well as the preset EQ mode will be shown by the corresponding LEDs NOT lighting up. You can find further details in the following chapters.

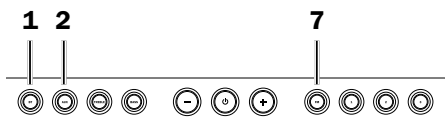

Volume

Setting the master volume

- With the $-/+$ buttons **(5)**, you can increase or decrease the volume in 32 steps. When changing the volume, the buttons $-/+$ **(5)** will illuminate and the current volume level will be indicated by the volume LEDs **(10)**.

Press the button briefly to change the volume gradually. Pressing and holding the button will change the volume continuously.

When the system is muted (lowest volume), all volume LEDs will blink.

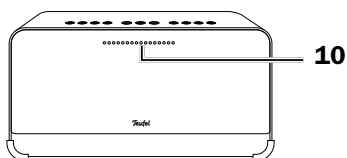
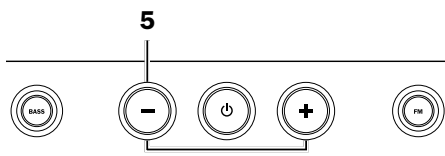

Tone

Setting the bass tones (subwoofer)

1. Press the BASS button **(4)**, to adjust the bass tones of the subwoofer to your listening pleasure. The current setting is indicated by the volume LEDs **(10)**.
2. As long as the BASS button **(4)** is lit, you can use the $-/+$ buttons **(5)** to change the volume of the subwoofer in 14 stages.

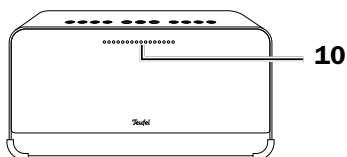
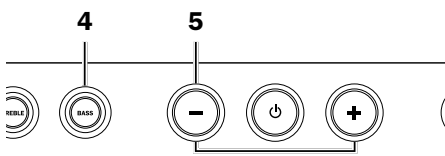

- To exit setup mode, you can press the BASS button **(4)** again. Otherwise, the mode will automatically end after approx. 5 seconds of key inactivity.

Setting the treble tones

- Press the TREBLE button **(3)**, to adjust the higher tones to your listening pleasure. The current setting is indicated by the volume LEDs **(10)**.
- As long as the TREBLE button **(3)** is illuminated, you can change the treble tones to 14 different levels using the -/+ buttons **(5)**.
- To exit setup mode, you can press the TREBLE button **(3)** again. Otherwise, the mode will automatically end after approx. 5 seconds of key inactivity.

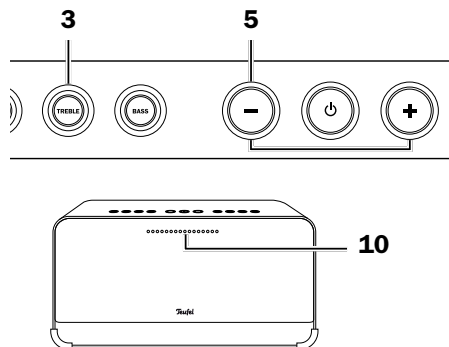

Preset sound configuration

There are 3 factory presets already stored. For BT or AUX mode, you can simply press the corresponding memory button **(8)**.

Memory button 1 – Neutral: bass and treble in a neutral position. This setting is suitable for most uses.

Memory button 2 – Loudness: the loudness setting is optimized for use in enclosed spaces. The bass and treble are raised to create a powerful sound, even with low and medium volume.

Memory button 3 – Outdoor: the outdoor setting is optimized for use outdoors, without wall reflections. Here, the high tones are raised and the low

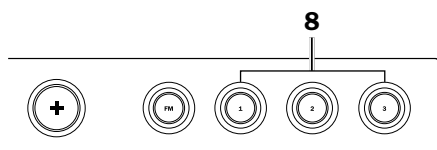

notes slightly lowered to compensate for ambient noise and prolong the battery life.

The presets can always be customized and saved to your personal taste (see next section).

Saving personal sound configurations

In BT/AUX mode you can save 3 sound configurations using the memory buttons **(8)**.

1. Adjust the tones as described above.
2. Press and hold the desired memory button until the buttons **TREBLE (3)**, **BASS (4)** and the respective memory button flash three times.
Now the sound configuration is saved.
3. You can access the saved tone configurations by pushing the corresponding memory button **(8)** in BT or AUX mode.

i Access is not possible in radio mode (FM) because the memory buttons act as station buttons here. In this case, briefly switch to another source (e.g. AUX), access the tone configuration there and switch back to FM.

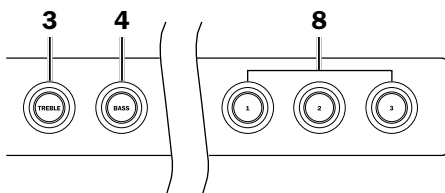

Radio

The BOOMSTER XL is equipped with an FM radio. Three memory slots are available for your favourite stations. The integrated dipole FM antenna ensures good reception.

Selecting the radio

- Open the antenna compartment and unwind the dipole FM antenna (**18**). If applicable, adjust its position for better reception later.
- Briefly push the **FM button (7)** to select the radio. The **FM** button LED is switched off now.

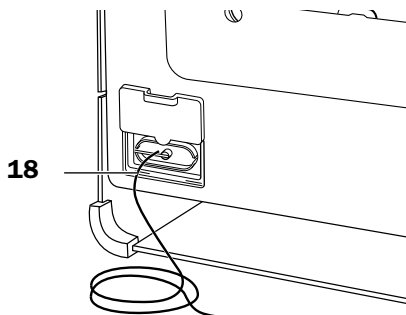

Setting stations

- Tap the FM button (**7**) again to scan for the next radio station and set it. If necessary, push the FM button (**7**) again until you have found the desired station.

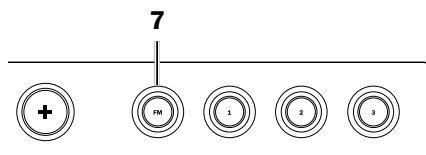

Saving and accessing stations

- If you would like to save the set station, push and hold one of the memory buttons (**8**) for approx. 3 seconds. The memory button and FM button (**7**) will flash three times. The station has now been saved to this memory button.
- You can access the saved stations by briefly pushing the corresponding memory button.

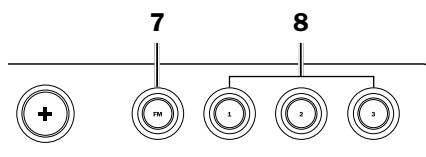

AUX

Connection

The **AUX IN (16)** jack serves to connect an external player using a stereo cable with a 3.5 mm jack plug. You can connect any external players with a line-out jack or earphone jack.

Playback

1. Push the AUX button **(2)** to select the AUX input.
The button will illuminate.
2. Start playback on your external player.

i The volume setting of the external player affects the volume of the BOOMSTER XL. The sound can be set exclusively to your BOOMSTER XL.

3. Use your external player to control all other playback functions.

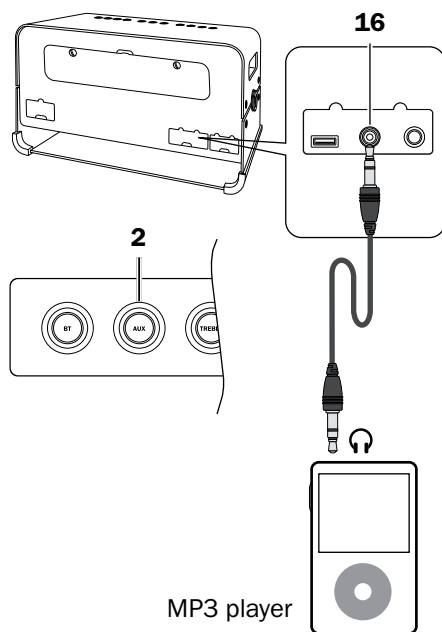

Bluetooth®

Via Bluetooth®, you can establish a wireless connection between a compatible external player and the BOOMSTER XL. The audio output of your external player is then emitted by the BOOMSTER XL.

NOTICE

Only use the Bluetooth® function in locations where wireless radio transmission is allowed.

Please keep in mind that the Bluetooth® and NFC behaviour may differ depending on the external player's operating system.

Bluetooth® options

Depending on the device type, your external player/smartphone may also have a number of Bluetooth® options such as media playback and call function. Here you can activate and deactivate the options according to your wishes.

You can find more information about the Bluetooth® options in the user manual for your external player/smartphone.

Pairing

To play the audio of your external player on your Boomster via Bluetooth, you must first connect the devices with each other. The technical term for this is "pairing". The Boomster XL provides manual and automatic pairing via NFC.

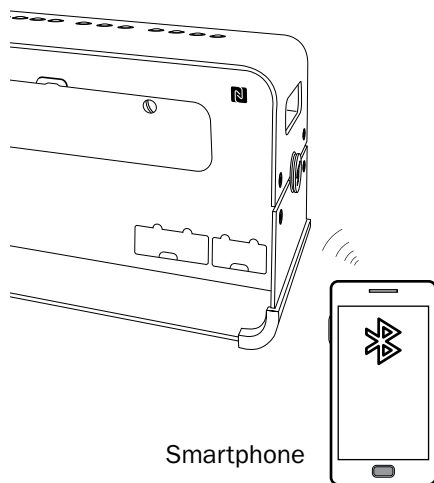

Manual pairing

1. Turn on the Bluetooth® function on your external player (e.g. smartphone).
2. Press the **BT (1)** button and hold it down for approximately 3 seconds. When the BT button LED blinks, the external player can be linked.
3. Let your external player/smartphone scan for Bluetooth® devices. You will find more information about this in the user manual of your external player.
“BOOMSTER XL” should also appear in the list of detected devices following the scan.
4. Select “BOOMSTER XL” from the list of detected devices.
Pairing is now complete and your BOOMSTER XL will now act as a Bluetooth® playback device. The BOOMSTER XL will now play back all sounds that would otherwise be played by your external player/smartphone.

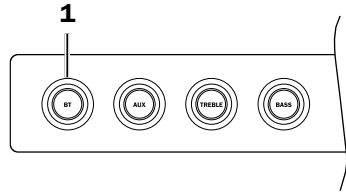

i When BT is set as the active source and a Bluetooth®-connection is available, the BT button LED will be off (all other LEDs will be on).

Pairing via NFC

NFC (Near Field Communication) is a transmission standard for the wireless exchange of data over short distances. Your BOOMSTER XL can create a connection to a compatible external player via NFC.

1. Turn on the NFC function on your external player (Bluetooth® does not have to be turned on for the external player).
2. Hold your external player close to the NFC contact zone  on the rear side of the BOOMSTER XL.
If FM or AUX is selected as the source, the BOOMSTER XL will automatically switch to Bluetooth® mode. After a short time, you will be asked to allow the NFC connection.
3. Confirm the request on your external player.
Pairing is now complete and your BOOMSTER XL will now act as a Bluetooth® playback device. The BOOMSTER XL will now play back all sounds that would otherwise be played by your external player/ smartphone.

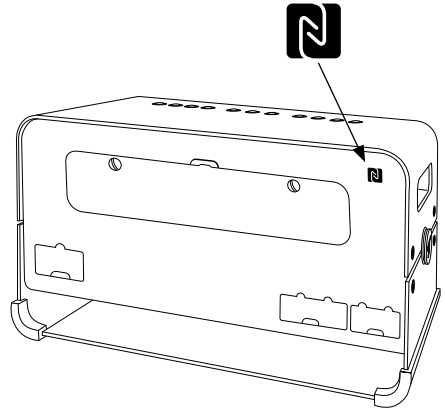

Playback

 The volume setting of the source device also has an impact on the volume of the BOOMSTER XL. The sound can be set exclusively to your BOOMSTER XL .

- After starting playback on your source device, you can control the other playback functions from here as well.

Terminating the connection

To terminate the Bluetooth® connection,

- deactivate the Bluetooth® function on your external player/smartphone.
- or push and hold the BT button **(1)** for approx. 3 seconds, which will cause the pairing to be terminated.

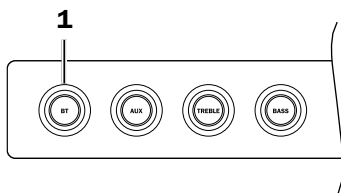

USB

The USB connector **(17)** is used to supply power and recharge the source devices such as smartphones, tablets or MP3 players. Charging with the BOOMSTER XL however, can take longer than with the appropriate power adapter.

NOTICE

Please note that charging a device may reduce the rechargeable battery life of your BOOMSTER XL.

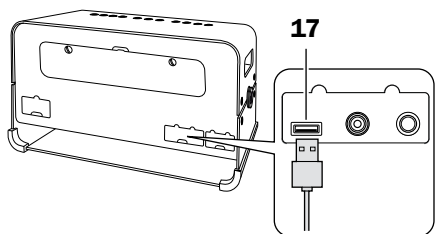

Remote Control

You can use the “Teufel Puck” remote control as an optional accessory.
Available in our webshop.

Pairing the “Teufel Puck”

1. Switch the BOOMSTER XL on.
2. Position the “Teufel Puck” at a distance of no more than 25 cm to the BOOMSTER XL.
3. Hold the button **(20)** down until the LED ring **(22)** starts to blink. Then release the button.
 - Blinks three times: Pairing was successful.
 - Blinks ten times: Pairing failed and must be repeated.

Functions

- **Activating and deactivating the BOOMSTER XL or “Teufel Puck”:**

Push the  **(21)** for approx. 3 seconds.

Tapping the  is sufficient to switch on from standby (only works in mains mode, not in battery mode).

- **Selecting a source:**

Push the button **(20)** repeatedly.

- **Adjusting the volume:**

Turn the cover **(21)**.

- **Mute:**

Tap the  **(21)**.

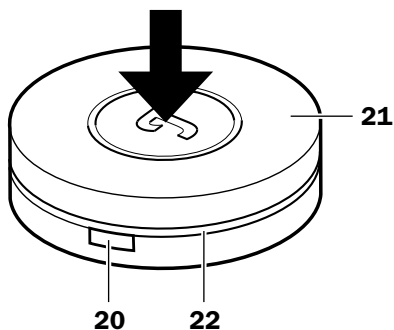

Changing the batteries

The remote control is powered by 2 type AAA batteries. Simply pull off the cover to open the battery compartment.

NOTICE

When inserting the batteries, make sure that the polarity is correct.

⚠ CAUTION

Batteries (particularly lithium batteries) can explode if used improperly.

- Never attempt to recharge batteries.
- Only use batteries of the same or equivalent type.
- Do not heat, short circuit batteries and rechargeable batteries, dispose of them in a fire or expose them to direct sunlight.

Leaking battery acid may lead to chemical burns.

- Do not allow battery acid to come into contact with skin, eyes or mucous membranes. In the event of contact with acid, immediately flush the applicable areas with plenty of clean water and consult a physician if necessary.

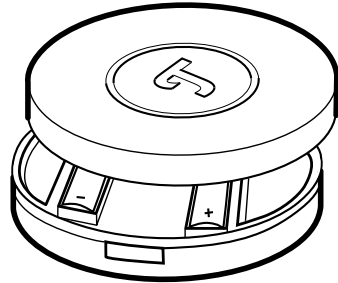

Cleaning & Maintenance

NOTICE

External influences may damage or destroy the device.

- *If the device is to be left unattended for a prolonged period of time (e.g. during a vacation) or if a thunderstorm is forecast, pull the mains plug out of the socket. Otherwise, sudden overvoltage could damage or destroy the device.*
 - *In the event of a prolonged absence, remove the batteries from the device. Leaking batteries may damage the device.*
 - *If possible, only use plain water without any additives. In case of stubborn marks, a mild soap solution may be used.*
- *Do not use caustic cleaning products, white spirit, thinners, petrol or similar under any circumstances. Such cleaning agents may damage the delicate surface of the housing.*
 - Ideally, you should remove dust or small amounts of dirt with a dry, smooth microfiber cloth.
 - Use a damp cloth to rub off stubborn dirt. Make sure that no liquid penetrates the housing.
 - Then immediately wipe the damp surfaces off with a soft cloth without applying pressure.

Troubleshooting

The following advice should help you to solve problems. If this does not help, you will find useful information in the detailed FAQs on our website. Otherwise, please contact our hotline (see page 4). Take note of the warranty instructions.

Problem	Possible cause	Solution
The BOOMSTER XL doesn't emit sound.	No power supply.	Check the function of the socket with another device.
		Charge the rechargeable battery.
No sound.	The wrong source has been selected.	Select the correct source (see "Selecting a source" on page 15).
	The volume has been set too low.	Increase the volume.
	The volume of the external player has been set too low.	Carefully increase the volume of the external player.
No sound in Bluetooth® mode.	No Bluetooth® connection.	Establish a connection (see "Pairing" on page 20).
	BOOMSTER XL has not been selected as the output device.	On the external player, select "BOOMSTER XL" as the Bluetooth® output device.
	Bluetooth® connection impaired by another radio system (e.g. cordless telephone, Wi-Fi).	Set up the BOOMSTER XL and/or external player in another location. Move to another room to test.
Playback is noisy.	Generally speaking, the BOOMSTER XL is a very low-noise system. It has a very high resolution in the high range area and therefore can expose the poor quality of a signal source (e.g. from MP3 files).	Make sure that the external player emits a clear signal to the BOOMSTER XL.

Protecting the Environment



Old devices must not be disposed of with household waste!

■ If the device is no longer operational, every consumer is required by law to dispose of old devices separately from household waste, e.g. at a collection point run by the communal authority/borough. This ensures that old devices are recycled in a professional manner and also rules out negative consequences for the environment.

For this reason, electrical equipment is marked with the adjacent symbol.



Batteries and rechargeable batteries do not belong in the household garbage!

Every consumer is required by law to bring all batteries and rechargeable batteries, regardless whether they contain harmful substances* or not, to a collection point run by the communal or borough authority, or to a retailer, so that they can be disposed of in an environmentally friendly manner.

Please only turn in batteries and rechargeable batteries which are empty!

* labelled with: Cd = cadmium, Hg = mercury, Pb = lead

Technical Data

Dimensions (WxHxD):	510 x 257 x 210 mm
Weight:	9.85 kg
Mains connection:	230 V~; 50/60 Hz; 150 W
Rechargeable battery:	12 V Li-ion; 8000 mAh; 88.8 Wh

You can find further technical data on our website.
Technical changes reserved!



EG-Konformitätserklärung EU-Declaration of Conformity

Hiermit bestätigen wir, dass das nachfolgend bezeichnete Gerät den angegebenen-Richtlinien entspricht.

We herewith confirm that the appliance as detailed below complies with the mentioned directives.

Artikelbezeichnung: Boomster XL

Article description:

Firmenanschrift: Teufel Lautsprecher GmbH
Company address Budapester Straße 44
D-10787 Berlin

Einschlägige EG-Richtlinien / Governing EU-directives / Directives CE concernées :

- | | |
|--|---|
| <input checked="" type="checkbox"/> 1. Elektromagnetische Verträglichkeit (EMV)
Electromagnetic compatibility (EMC)
2004/108/EC | <input checked="" type="checkbox"/> 2. Niederspannungs-Richtlinie
Low-voltage directive
2006/95/EC |
| <input type="checkbox"/> 3. Sicherheit von Spielzeug
Safety of toys
88/378/EEC, amended 93/68/EEC | <input type="checkbox"/> 4. Medizinprodukte (Klasse 1)
Medical device directive (Class 1)
93/42/EEC |
| <input checked="" type="checkbox"/> 5. Funkanlagen und
Telekommunikationsendeinrichtungen
Radio and Telecommunication Terminal Equipment
R&TTE 1999/5/EC | <input checked="" type="checkbox"/> 6. Ökodesign – Richtlinie
Energy – Using – Product – Directive (EuP)
2009/125/EEC |
| <input checked="" type="checkbox"/> 7. Richtlinie zur Beschränkung der Verwendung
bestimmter gefährlicher Stoffe in Elektro- und
Elektronikgeräten (RoHS- Richtlinie 2011/65/EC) | |

Harmonisierte EN-Normen / Harmonised EN-Standards

Der Artikel entspricht folgenden, zur Erlangung des CE-Zeichens erforderlichen Normen:
The article complies with the standards as mentioned below which are necessary to obtain the CE-symbol:

DIN EN 55013:2013
DIN EN 55020:2012
DIN EN 61000-3-2:2010
DIN EN 61000-3-3:2014
DIN EN 60065: 2011
DIN EN 62133: 2013
DIN EN 62321: 2009
ETSI EN 301489-1
ETSI EN 301489-09
ETSI EN 300328 V 1.8.1:
Verordnung 1275/2008
Verordnung 0278/2009
UN38.3

Edgar van Velzen

Geschäftsführer

Ausstellungsdatum / Date of issue: 03. September 2015

Teufel

Please contact our customer service with any questions, suggestions or comments:

Lautsprecher Teufel GmbH
BIKINI Berlin
Budapester Str. 44
10787 Berlin (Germany)

Phone: 00800 - 200 300 40 (toll-free)
Fax: +49 (0)30 - 300 930 930
www.teufelaudio.com

No responsibility is assumed for the correctness of this information.
Technical changes, typographical errors and other errors reserved.