

Technical Description and Operating Instructions

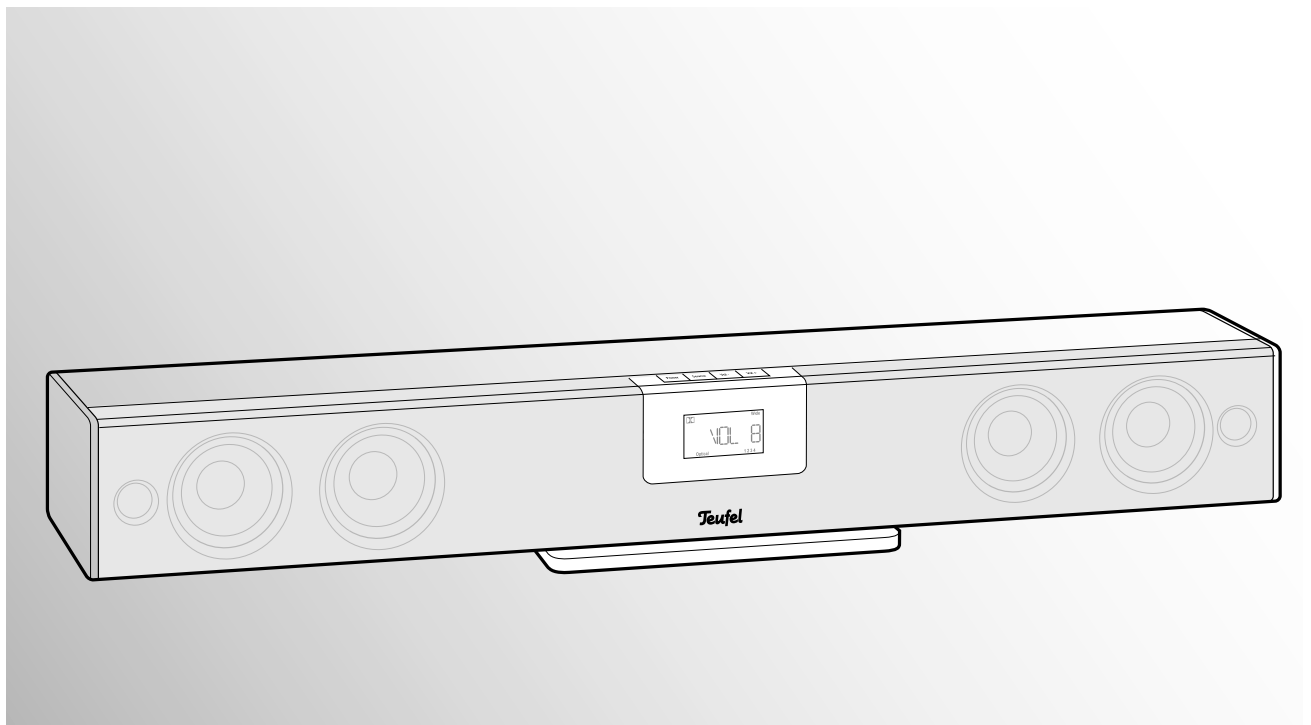

Cinebar® 21

2.1 Soundbar

Teufel

Contents

Technical Description and Operating Instructions	1
Contents.....	2
General notes and information	3
Notice	3
Original packaging.....	3
Trademarks	3
Complaints.....	3
Contact	3
Proper use.....	3
Safety notes	4
Caution icons	4
Safety notes	4
Overview	6
Check to be sure.....	6
Setup/wall mounting	7
Setup location	7
Wall mounting.....	7
Control elements and connections	8
The battery	9
Changing the batteries	9
Connection example	10
Settings.....	11
Basic functions.....	11
Adjust the sound	11
Display brightness.....	11
Lip Sync.....	11
Care and cleaning	12
Protecting the environment	12
Batteries and rechargeable batteries.....	12
Disposing the unit	12
Troubleshooting.....	13
Technical data	13

General notes and information

Notice

The information in this document may change without prior notice and in no way constitutes any liability on the part of Lautsprecher Teufel GmbH.

No part of these instructions may be reproduced in any form or be broadcasted in any way electronically, mechanically, by photocopy or recording without the written permission of Lautsprecher Teufel GmbH.

© Lautsprecher Teufel GmbH
Version 1.0
September 2012

Original packaging

If you wish to exercise your eight-week right of return, we ask that you be absolutely sure to hold onto the packaging. We can only accept the return of the device with ORIGINAL-PACKAGING.

Empty boxes are not available!

Trademarks

© All trademarks are the property of their respective owners.



Dolby

Manufactured under license from Dolby Laboratories. Dolby and the double-D symbol are trademarks of Dolby Laboratories.



DTS

Manufactured under license under U.S. Patent Nos: 5,956,674; 5,974,380; 6,487,535 & other U.S. and worldwide patents issued & pending. DTS, the Symbol, & DTS and the Symbol together are registered trademarks & DTS Digital Surround and the DTS logos are trademarks of DTS, Inc. Product includes software. © DTS, Inc. All Rights Reserved.

Complaints

In case of complaint we will need the following information to process your enquiry:

1. Invoice Number

Can be found on the sales slip (enclosed with the product) or on the order confirmation received as a PDF document, e.g. 4322543.

2. Serial number or batch number

Located on the back side of the unit, e.g. serial #: IL30009440122A-123

Many thanks for your support!

Contact

For questions, suggestions or criticism please contact our customer service department:

Lautsprecher Teufel GmbH
Gewerbehof Buelowbogen
Buelowstrasse 66
10783 Berlin (Germany)

Phone 00800 - 200 300 40 (free of charge)

Fax +49 (0)30 / 300 930 930

E-mail: service@teufelaudio.com

www.teufelaudio.com

Proper use

The speaker set is designed for audio signal playback. Use the unit only as described in these operating instructions. Any other use will be deemed as not in accordance with the instructions and may lead to damage of property or even persons.

The manufacturer accepts no liability for damage caused by use not in accordance with the instructions.

The unit is intended for private use.



Before operating the unit for the first time please read the safety notes and operating instructions carefully. This is the only way to use all functions safely and reliably.

Keep the operating instructions safe and pass them on to anyone who may own the unit after you.

Safety notes

Caution icons

You will find the following caution icons in these instructions:

Danger High risk!

Failure to observe the warning may result in severe personal injury or death.

Attention Moderate risk!

Failure to observe the warning may result in property damage.

**Minor risk!**

Points which should be observed when handling the unit.

Safety notes

Danger Risk of electric shock!

Faulty installation of electrical equipment or mains voltage which is too high can cause

electric shocks.

- The device is only suitable for use with a power supply voltage of 230 V~/50 Hz.
- If the unit's case or mains cable is defective or shows other signs of visible damage, disconnect the mains adapter immediately from the socket and do not operate the device.
- In the event of damage, a power supply cable with a fixed connection to the device must be replaced by the manufacturer, the manufacturer's customer services or a similarly qualified person in order to ensure safety.
- If the unit emits smoke or smells of burning or other unusual odours, disconnect it immediately from the power supply and do not operate it.
- The button **Power (I)** does not disconnect the device from the power supply. For this reason, connect it to an easily accessible socket so that you can quickly disconnect it from the power supply in the event of faults.
- Never open the unit's housing.
Repairs may only be carried out by an authorised specialist workshop. Only parts which conform with the original unit specifications may be used in this case. There are electrical and mechanical parts in this unit which are necessary in order to avoid exposure to sources of danger.
- Do not insert any objects through the vent slots in the housing.
- Only use the unit in indoor areas.
- Do not operate the unit in damp areas and protect it from drops or splashes of water.
Also take care not to stand vases or other containers of liquid on or near the unit in order to avoid liquid getting into the case. If water or other foreign objects

penetrate the case, immediately disconnect the power plug and if applicable, remove any batteries. Send the unit to our service address in this case.

- Never touch the mains adapter with damp hands.
 - Check the unit regularly for damage.
-

Danger Danger to children!

Children can become trapped in the packing film when playing and suffocate.

- Do not allow children to play with the unit or the packing film. Danger of suffocation.
 - Ensure that children do not remove small parts from the unit or take them off of the unit (e.g. button cells from the remote control, knobs or plug adapters). They could swallow the parts and choke.
If a battery is swallowed, immediately consult a physician with the child.
 - Never allow children to operate electrical devices unsupervised.
-

**Danger to hearing!**

Loud noise may lead to hearing loss.

Very high noise pressure may suddenly be emitted, especially if a subwoofer is activated and set to full volume. This may have psychological consequences and also cause physical injury. Children and pets are particularly at risk.

- Set your signal source unit volume control to a low setting.
 - When the volume is set high, always keep a certain distance from the unit and never place your ear directly on the speaker.
 - To avoid damage to health, avoid extended listening at high volume.
-

Danger Health hazard!

Swallowing the enclosed battery may lead to severe internal injuries or even to death.

- Store both new and used button cell batteries out of the reach of children.
 - If the battery compartment can't be safely closed anymore, stop using the product and store it in a place, which is not accessible to children.
 - If you suppose that a button cell battery was swallowed or ingested in another way, seek immediate medical attention.
-

Danger Danger of chemical burns!

Leaking battery acid may lead to chemical burns.

- Do not allow battery acid to come into contact with skin, eyes and mucus membranes. In case of contact with acid rinse the affected location immediately with plenty of plain water and if necessary see a doctor.
-

Danger Danger of explosion!

Lithium batteries can explode if handled improperly.

- Never attempt to recharge lithium batteries.
 - Only use batteries of the same or equivalent type.
 - Do not heat or short circuit batteries and rechargeable batteries and do not dispose of them in fire. Also never expose batteries and rechargeable batteries to direct sunlight.
-

Danger Danger of injury/damage!

Incorrect location may result in damage.

- Never use the unit unmounted in vehicles, in unstable locations, on wobbly stands or furniture, on underdimensioned brackets etc. The speakers could tip or fall down and cause injury to persons or be damaged.
 - Arrange the speakers so that they cannot be knocked over accidentally and make sure that the cables do not pose a trip hazard.
 - If mounting the speakers on the wall, make sure that the job is carried out by a professional.
 - Only use suitable wall holders to mount the speakers. Verify the carrying capacity of the walls.
 - Do not place the unit near sources of heat (e.g. heaters, ovens, other heat generating equipment such as amplifiers etc.)
-

Attention Fire hazard!

Improper use may lead to damage or fire.

- Do not place open flames such as burning candles or similar on the unit.
 - Ensure sufficient ventilation.
 - Do not place the unit in direct sunlight.
 - Do not cover the ventilation slots with curtains, cloths, newspapers or similar. Heat build-up inside the unit can shorten the lifetime of the unit.
-

Attention Risk of damage!

Power overload due to lightning strike may damage or destroy the unit.

- If the unit is to be left unsupervised for a long period (e.g. during a holiday), or if a thunderstorm is forecast, disconnect it from the mains power supply. Leaked batteries may damage the remote control.
 - In case of prolonged absence, remove the battery from the remote control.
-

Overview

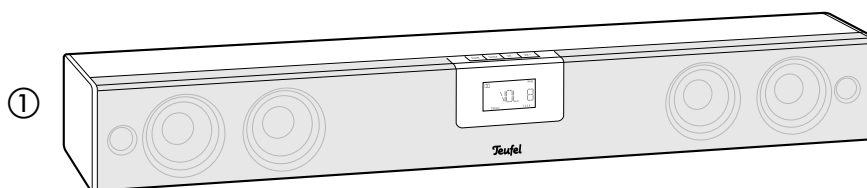

Product contents

- ① 1 x Cinebar 21
- ② 1 x stand for Cinebar 21
- ③ 1 x remote control
- ④ 1 x power cord
- ⑤ 1 x RCA cable for Cinebar subwoofer connection

Check to be sure

- Check that all items have been delivered and that nothing is damaged.
- If the delivery is incomplete or you find damage sustained in transit, do not operate the unit but contact our service department (see page 3).

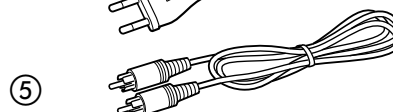
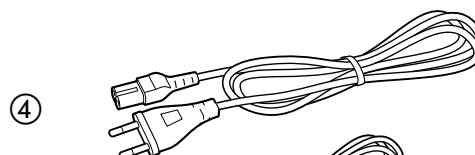
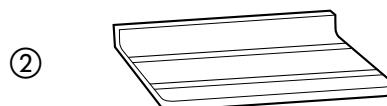

Setup/wall mounting

Setup location

Cinebar 21

A location directly under the TV set is ideal. Hang the **Cinebar 21** either directly to the wall or place it on the stand ② below the TV set.

Subwoofer

If possible, you should also place the subwoofer on the floor close to the television. However, you can also set it up in another location in the room as the listener's ears are unable to locate lower tones.

Operating the device in the corner of a room is not recommended.

Location tips

- Select a stable, level base.
Please consider the following chapter when mounting the device on the wall.
- Make sure that the environment is clean and free from dust.
- Avoid placing the unit close to sources of heat or in direct sunlight.
- Arrange the connector cables so that they do not pose a trip hazard.
- Do not place any heavy objects on top of the cables or the units.

Wall mounting

You will need the following material for wall mounting on a solid stone wall:

- 2 x dowels (ø 8 mm)
- 2 x screws, 5 x 50 mm
(screw head = ø 10–12 mm)

Danger Risk of damage and electrical shock!



Proceed with caution when mounting the device on the wall and follow the instructions provided below.

- Only skilfull persons may mount the **Cinebar 21** on the wall.
- The product may only be mounted on a suitable, solid wall. Special dowels or brackets may be necessary for walls with a lightweight construction. Consult a professional.
- Make sure that no cables or pipes are located in the areas where you are drilling. Use a metal detector to check the areas before drilling.

1. Mark the hole distance between the two wall mounting profiles of 61.25 cm on the wall where you intend to install the **Cinebar 21**. Use a folding rule, pencil and level for this purpose.
2. Use a metal detector to ensure that there are no cables or pipes in the areas where you intend to drill. If necessary, select another place for installation.
3. With an 8 mm masonry drill, drill a hole that is approx. 45 mm deep at each of the marked positions.
4. Insert 2 dowels (ø 8 mm) completely in the drill holes.
5. Screw one screw (5 x 50 mm) into each of the dowels until the distance between the wall and screw head is approx. 4 mm.

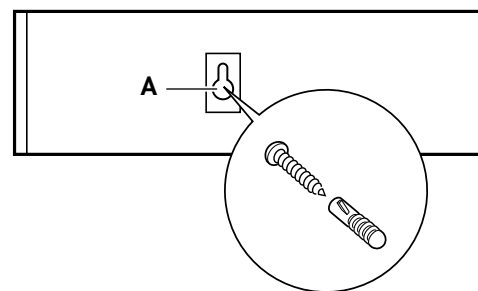

6. Push the **Cinebar 21** up against the wall so that the screws disappear into the holes **A**. Now pull the **Cinebar 21** down so that the screws slip into the narrow slot.
7. If necessary, turn the screws further into or out of the holes until the **Cinebar 21** is firmly mounted on the wall.

Control elements and connections

Cinebar 21 – Top and front side

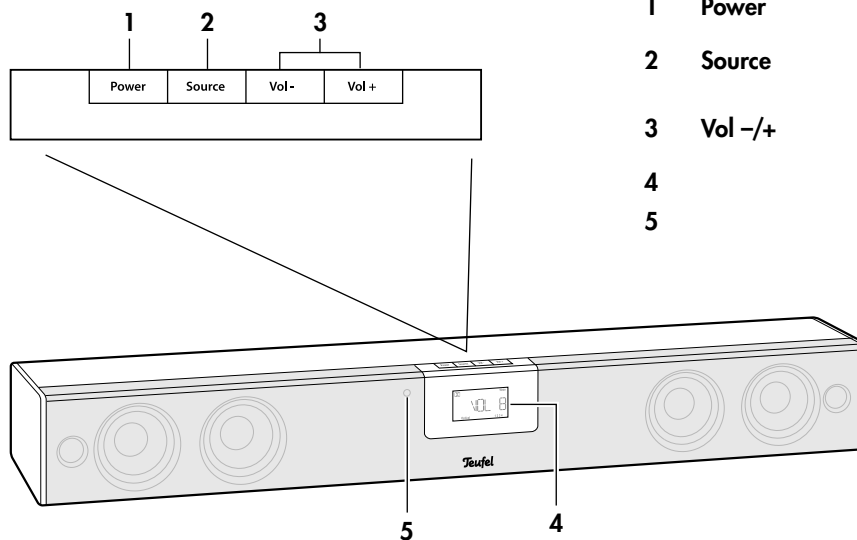

Item	Name	Description
1	Power	Switch the device on or to standby
2	Source	Select an input jack (Aux In, Digital In Optical, Digital In Coaxial)
3	Vol -/+	Increase (+) / reduce (-) volume
4		Display
5		Standby LED

Cinebar 21 – Back side

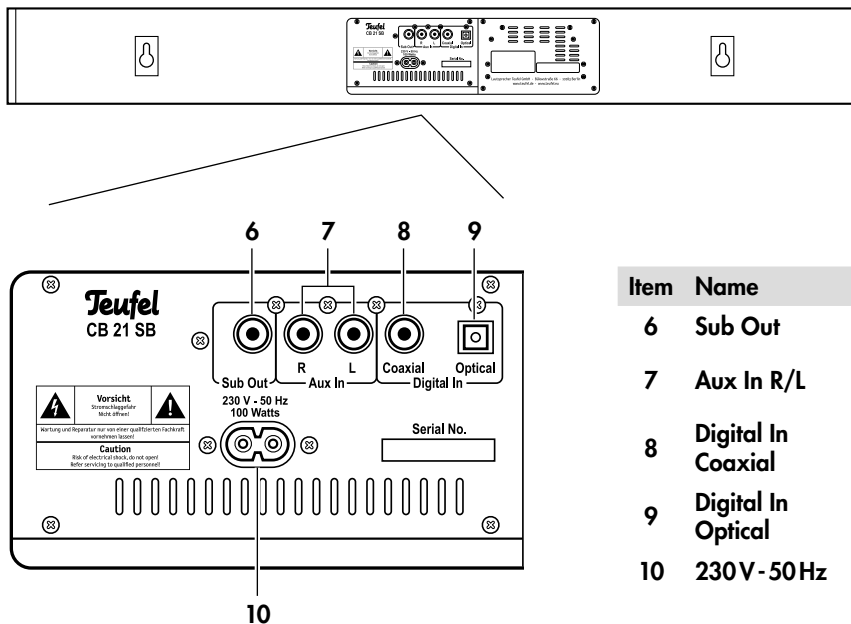

Item	Name	Description
6	Sub Out	RCA output jack for subwoofer
7	Aux In R/L	RCA input jacks for analogue audio signals from external players
8	Digital In Coaxial	RCA input jacks for digital audio signals from external players
9	Digital In Optical	TOSLINK input jack for digital (optical) audio signals from external players
10	230V - 50Hz	Euro 8 jack for power cord Ⓢ

Remote control

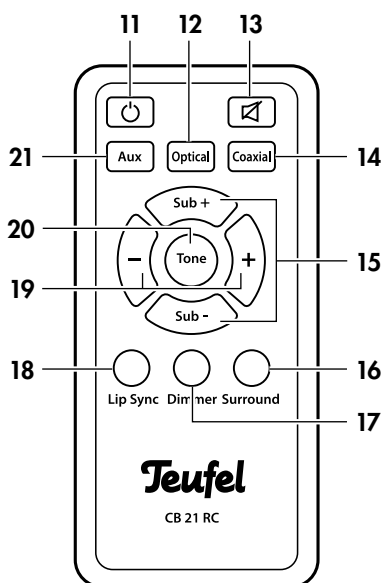

Item	Name	Description
11	⏻	Switch the Cinebar 21 on/to standby
12	Optical	Select Digital In Optical (9) as a source
13	🔇	Mute the speakers
14	Coaxial	Select Digital In Coaxial (8) as a source
15	Sub +/-	Reduce subwoofer volume
16	Surround	Activate and deactivate surround sound effects
17	Dimmer	Adjust the display brightness
18	Lip sync	Synchronise speech and film
19	+ / -	Increase (+) / decrease (-) volume
20	Tone	Increase / decrease bass and high range tones
21	Aux	Select Analog In (7) as a source

The battery

An insulating strip has been affixed between the battery and the contact in order to preserve the entire battery capacitance for delivery. Simply pull this strip out.

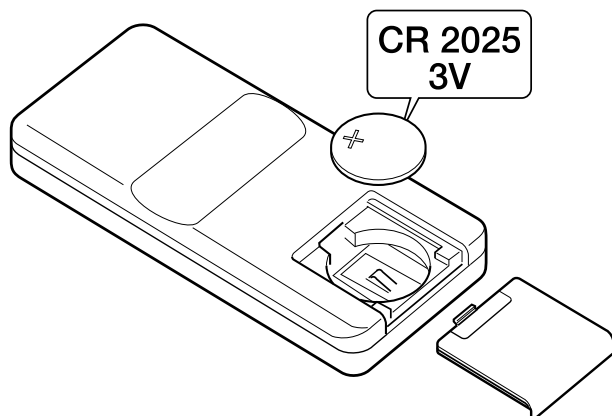

Changing the batteries

The battery should be replaced if the remote control stops functioning properly or no later than after 2 years. Battery type: CR 2025 LITHIUM BATTERY.

Remove the battery compartment cover from the remote control and replace the batteries in order to change the batteries.

Make sure that the polarity is correct!

Danger Danger of explosion!



Lithium batteries can explode if handled improperly.

- Never attempt to charge the lithium battery.
- Only insert a battery of the same or equivalent type.
- Do not heat, short circuit or dispose of the battery in fire.

Do not subject the batteries to direct sunlight.

Connection example

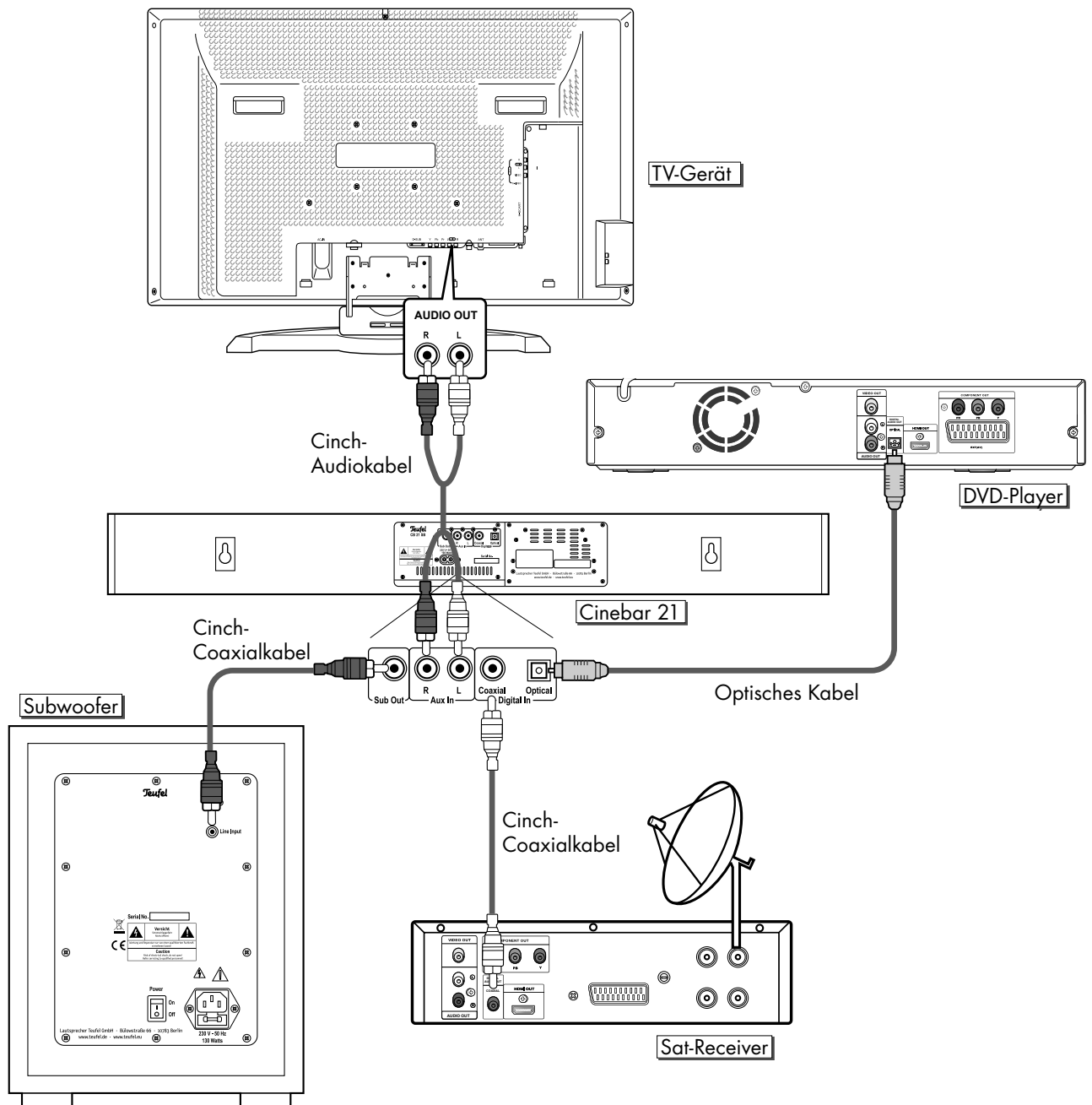

- This connection example only provides a few possibilities for connecting the device. There are often different connecting methods possible for a device. Please consult the operating instructions of the respective device for more information in this regard.
- If your TV set does not have separate audio output jacks, you can relay the sound to the **Cinebar 21** using a scart/RCA adapter.
- Once you have connected all devices, you can also connect the **Cinebar 21** and the subwoofer to the power supply using the enclosed power cord. Make sure that the sockets are easily accessible.

- If you have connected and activated the devices as described in this example, you must set the **Cinebar 21** as follows:

Device audio	Transfer	Cinebar setting
TV set	analogue	Aux
DVD player	digital	Optical
Sat receiver	digital	Coaxial

Table 1

Basic functions

Activating and deactivating

- With the **Power (1)** button or **⏻ (22)**, you can switch your **Cinebar 21** on or to standby. The standby indicator **(5)** will illuminate in red in standby mode.

Selecting a source

Also see page 10, table 1.

- Push the device button **Source (2)** until the connector jack of the desired source appears on the display.
- On the remote control, select the source with the buttons **Aux (32)** or **Optical (23)** or **Coaxial (25)**. The respective setting will appear on the display.

Adjust the volume

- On the device: Push the buttons **Vol +/- (3)**.
- Using the remote control: Push the **buttons +/- (30)**.

Mute (switching to mute)

- You can activate or deactivate the sound by pushing the button **🔇 (24)** repeatedly.

Adjust the sound

You can only adjust the sound settings with the remote control only.

Selecting sound effects

Your **Cinebar 21** is equipped with Dolby Virtual Speaker technology. This simulates the audio impression of a 5.1 surround sound system using the soundbar.

Two sound effects are possible:

- The surround sound effect: **Reference**
- An effect that makes the distance between the speakers appear greater: **Wide**
- If necessary, push the **Surround (27)** button several times to set the desired sound effect. The respective setting will appear on the display.
- If no surround sound effect has been selected, then the audio will be emitted in stereo.

Adjusting bass and high-range tones

In addition to the sound effects, you can also increase or decrease the bass and high-range tones individually.

1. Push the button **Tone (31)** several times if necessary. You will either see the setting for the bass tones (e.g. **BASS +2**) or for the high-range tones (e.g. **TREB -1**) on the display.
2. With the buttons **+/- (30)**, adjust the respective setting to your taste.

Adjusting the subwoofer volume

- Adjust the subwoofer volume with the buttons **Sub +/- (30)**.

Display brightness

- Push the button **Dimmer (28)** several times if necessary in order to set one of the display's 3 brightness levels.

Lip Sync

During playback of movies, the picture and sound are not synchronous sometimes. You can eliminate this bothersome effect with your Cinebar 21.

- Push the button **Lip Sync (29)** and then adjust the delay between the picture and sound using the buttons **+/- (30)**. Values can be adjusted between 0 and 200 ms.

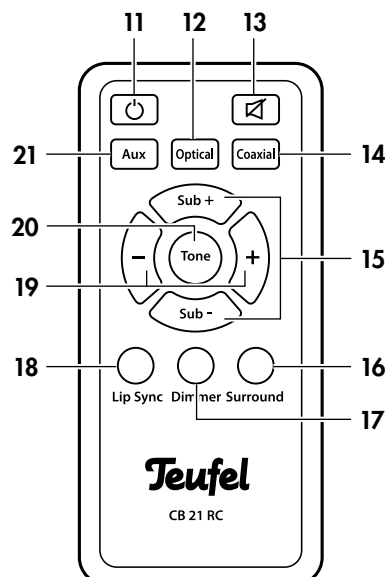

Care and cleaning

Clean your **Cinebar 21** regularly with a soft, damp microfibre cloth. When doing so, please be absolutely sure to observe the following instructions:

Danger Risk of electric shock!



In contact with live parts, water can lead to electric shock or short circuit.

- Ensure that no liquid penetrates the unit.
- Disconnect the mains plug before cleaning.

Attention Risk of damage!



Using the wrong cleaning materials may damage the delicate surface of the case.

- If possible, only use plain water without any additives. In case of stubborn marks, a mild soap solution may be used.
- In no circumstances should caustic cleaning products, white spirit, thinners, petrol or similar be used for cleaning.

Protecting the environment

Batteries and rechargeable batteries



Batteries and rechargeable batteries must not be disposed of with household waste!

Every consumer is required by law to bring all batteries and rechargeable batteries, whether they contain harmful substances*) or not, to a collection point run by the communal authority or borough or run commercially, so that they can be disposed of in an environmentally friendly manner.

Please only hand in fully discharged batteries and rechargeable batteries!

*) labelled with: Cd = Cadmium, Hg = Mercury, Pb = Lead

Disposing the unit



Used units must not be disposed of with household waste.

If the unit is no longer operational, every consumer is required by law to dispose of used devices separately from household waste, e.g. at a collection point run by the communal authority or borough. In this way it is ensured, that used devices are properly recycled and that negative consequences on the environment are avoided.

For this reason, electrical equipment is labelled with the displayed symbol.

Troubleshooting

The following advice should help you to solve problems. If this doesn't work, the extensive FAQs on our website will surely provide you with support. Otherwise, please contact our hotline (see page 3). Take note of the warranty instructions.

Problem	Possible cause	Solution
The device emits no sound.	Wrong source selected.	Select the right source (see page 11).
	Device has been set to "mute".	Push the button  or adjust the volume.
	Volume is set to "0".	Increase the volume.
The sound is not optimal.	The settings are not correct.	Adjust the sound settings as described on page 11.
Playback is noisy.	Generally speaking, the Cinebar 21 is a very low-noise system. In most cases, the speaker system with exceptional resolution in the high range area can expose the poor quality of a signal source (e.g. from MP3 files).	Ensure that the source is sending a clean signal to the Cinebar 21 .

Technical data

Dimensions (WxHxD)	918 x 115 x 110 mm
Weight	6.2 kg
Operating voltage:	230 V~/50 Hz
Max. power consumption	100 watts

For further technical information, please view the product description on our website at www.teufelaudio.com.

Technical changes reserved!

 This product conforms with Council of the European Union guidelines 2004/108/EC and 2006/95/EC.

Teufel

For questions, suggestions or other issues please contact our customer service department:

Lautsprecher Teufel GmbH
Gewerbehof Buelowbogen - Ausgang D1
10783 Berlin (Germany), Buelowstr. 66

Tel.: 00800 200 300 40 (toll-free)
Fax: +49 (0)30-300 930 930
www.teufelaudio.com

No liability is accepted for the accuracy of this information. Technical changes, typographical errors and other errors reserved.